

Hand Towel Tissue

1 Inter (L) Fold Hand Towel



Inter / L / V Fold Hand Towel



No	Code	Specification	Packing	Total Sheets
1	Inter Fold Pulp	225mm x 200mm x 1ply	150 sheets x 27 packs x 1ctn	4050 sheets
2	L Fold Pulp	200mm x 200mm x 1ply	200 sheets x 20 packs x 1ctn	4000 sheets
3	L Fold (Econ) Pulp	200mm x 200mm x 1ply	200 sheets x 20 packs x 1ctn	4000 sheets

2 Multi (M) Fold Hand Towel



No	Code	Specification	Packing	Total Sheets
1	M Fold Big Pulp	230mm x 230mm x 1ply	200 sheets x 20 packs x 1ctn	4000 sheets
2	M Fold Medium Pulp	200mm x 230mm x 1ply	200 sheets x 20 packs x 1ctn	4000 sheets
3	M Fold Big Recycle	230mm x 230mm x 1ply	200 sheets x 20 packs x 1ctn	4000 sheets
4	M Fold Small Recycle	170mm x 210mm x 1ply	160 sheets x 25 packs x 1ctn	4000 sheets
5	M Fold (Econ)	200mm x 230mm x 1ply	200 sheets x 20 packs x 1ctn	4000 sheets

3 C Fold Hand Towel



No	Code	Specification	Packing	Total Sheets
1	C Fold Pulp	300mm x 230mm x 1ply	180 sheets x 20 packs x 1ctn	3600 sheets
2	C Fold Recycle	300mm x 230mm x 1ply	180 sheets x 20 packs x 1ctn	3600 sheets

4 5 (Compact Slim) Fold Hand Towel

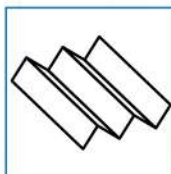

No	Code	Specification	Packing	Total Sheets
1	5 Fold Pulp	210mm x 250mm x 1ply	160 sheets x 22 packs x 1ctn	3520 sheets
2	5 Fold Recycle	190mm x 250mm x 1ply	160 sheets x 22 packs x 1ctn	3520 sheets

5 Center Flow (CFT) Hand Towel

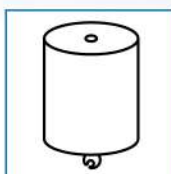

No	Code	Specification	Packing
1	CFT Pulp	250 meter x 200mm x 1ply	6 rolls x 1 ctn
2	CFT (Econ)	300 meter x 200mm x 1ply	6 rolls x 1 ctn

6 Hand Roll Towel (HRT) Hand Towel

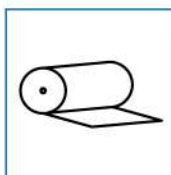

No	Code	Specification	Packing
1	HRT Pulp	150 meter per roll (1ply)	12 rolls x 1ctn
2	HRT Recycle	1kg per roll (1ply)	12 rolls x 1ctn

Facial Tissue

1 Hygiene Bath Tissue (HBT)

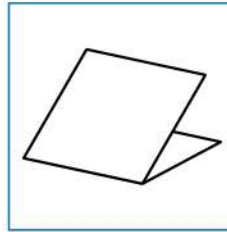

No	Code	Specification	Packing	Total Sheets
1	HBT 1 Ply Pulp	100mm x 200mm x 1ply	400 sheets x 36 packs x 1ctn	14400 sheets
2	HBT 2 Ply Pulp	100mm x 200mm x 2ply	250 sheets x 36 packs x 1ctn	9000 sheets
3	HBT 1 Ply Recycle	100mm x 200mm x 1ply	460 sheets x 36 packs x 1ctn	16560 sheets
4	HBT 2 Ply Recycle	100mm x 200mm x 2ply	250 sheets x 36 packs x 1ctn	9000 sheets

2 Pop Up Tissue

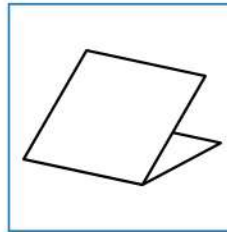

No	Code	Specification	Packing	Total Sheets
1	Clean Soft Pulp	100mm x 200mm x 1ply	250 sheets x 72 packs x 1ctn	18000 sheets
2	Clean Soft 2 Pulp	100mm x 200mm x 2ply	125 sheets x 72 packs x 1ctn	9000 sheets

3 Facial Tissue Box

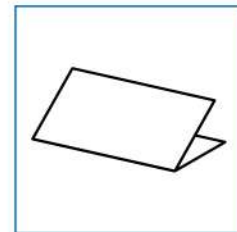

No	Code	Specification	Packing
1	Facial 40 Pulp	180mm x 200mm x 2ply	40 sheets x 100 box x 1ctn
2	Facial 90 Pulp	180mm x 200mm x 2ply	90 sheets x 80 box x 1ctn
3	Facial 500g Pulp (No Inner Box)	180mm x 200mm x 2ply	500g (~500 sheets) x 30 packs x 1 ctn
4	Facial 500 sheets Recycle (No Inner Box)	180mm x 180mm x 2ply	500 sheets x 30 packs x 1ctn

Toilet Tissue

1 Small Toilet Roll (Bathroom) Tissue

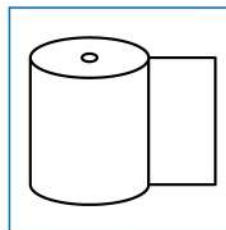

No	Code	Specification	Packing
1	STR 130 Pulp	130 sheets x 1 roll (2ply)	10 rolls x 10 packs x 1 bundle
2	STR 200 Pulp	200 sheets x 1 roll (2ply)	10 rolls x 10 packs x 1 bundle
3	STR 300 Pulp	300 sheets x 1 roll (2ply)	10 rolls x 10 packs x 1 bundle
4	STR Hotel Recycle	120 sheets x 1 roll (2ply)	10 rolls x 10 packs x 1 bundle
5	STR 160 Recycle	160 sheets x 1 roll (2ply)	10 rolls x 10 packs x 1 bundle

2 Jumbo Roll Tissue (JRT)

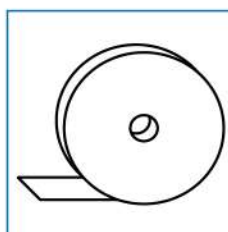

No	Code	Specification	Packing
1	JRT 130 Pulp	130 meter x 1 roll (2ply)	12 rolls x 1ctn
2	JRT 200 Pulp	200 meter x 1 roll (2ply)	12 rolls x 1ctn
3	JRT 250 Pulp	250 meter x 1 roll (2ply)	12 rolls x 1ctn
4	JRT 500 Recycle	500 grams x 1 roll (2ply)	12 rolls x 1ctn
5	JRT 200 meter Recycle	200 meter x 1 roll (2ply)	12 rolls x 1ctn
6	JRT Single Ply Recycle	500 meter x 1 roll (1ply)	12 rolls x 1ctn
7	JRT 130 (Econ)	130 meter x 1 roll (2ply)	12 rolls x 1ctn
8	JRT 200 (Econ)	200 meter x 1 roll (2ply)	12 rolls x 1ctn

Restaurant Products

1 Cocktails Napkins

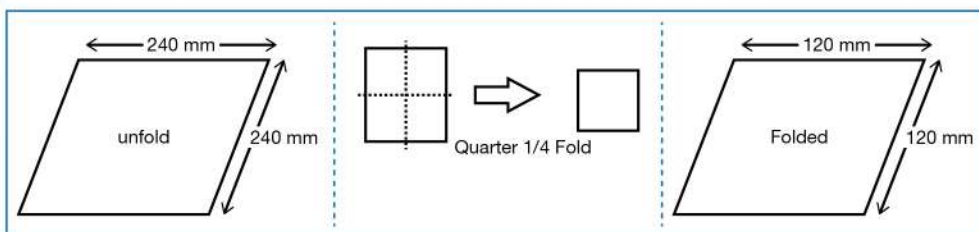

No	Code	Specification	Packing	Total Sheets
1	Cocktails 1ply Pulp / Kraft	240mm x 240mm x 1ply	200 sheets x 25 packs x 1 ctn (Plastic) 250 sheets x 20 packs x 1 ctn (Box)	5000 sheets 5000 sheets
2	Cocktails 2ply Pulp / Kraft	240mm x 240mm x 2ply	250 sheets x 20 packs x 1 ctn (Plastic) 100 sheets x 50 packs x 1 ctn (Box)	5000 sheets 5000 sheets

Note: Logo Printing Available

2 Luncheon Napkins

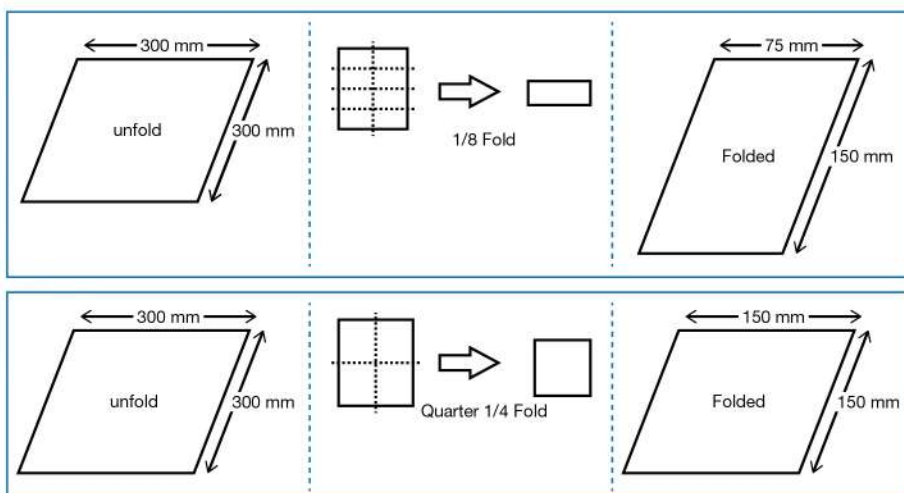

No	Code	Specification	Packing	Total Sheets
1	Luncheon 1ply Pulp / Kraft	300mm x 300mm x 1ply	200 sheets x 30 packs x 1ctn	6000 sheets
2	Luncheon 2ply Pulp / Kraft	300mm x 300mm x 2ply	100 sheets x 30 packs x 1ctn	3000 sheets

Note: Logo Printing Available

3 Dinner Napkins

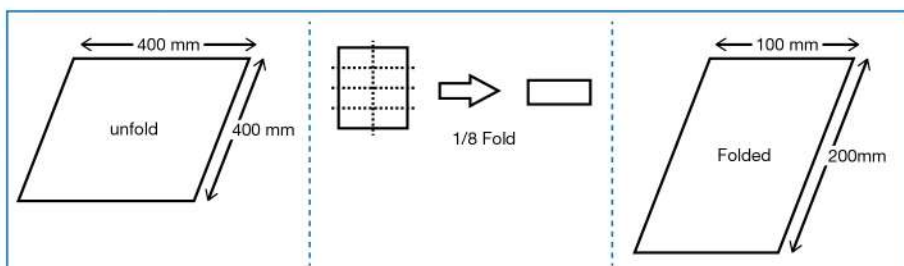

No	Code	Specification	Packing
1	Dinner 1ply Pulp / Kraft	400mm x 400mm x 1ply	200 sheets x 15 packs x 1ctn
2	Dinner 2ply Pulp / Kraft	400mm x 400mm x 2ply	100 sheets x 20 packs x 1ctn

Note: Logo Printing Available

4 Serviette

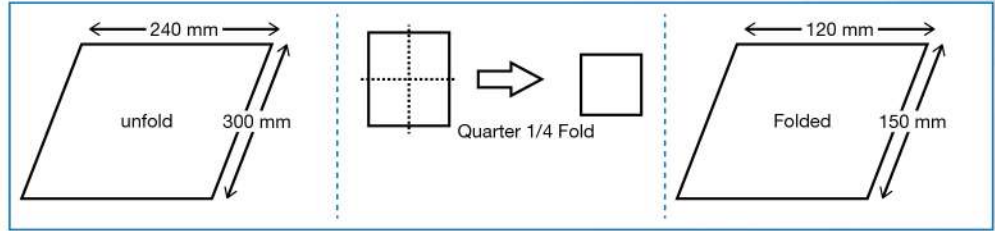

No	Code	Specification	Packing
1	Serviette Recycle (Pink or White)	240mm x 300mm x 1ply	100 grams x 60 packs x 1ctn
2	Serviette Pulp	240mm x 300mm x 1ply	100 sheets x 60 packs x 1ctn

Note: Logo Printing Available

5 Kitchen Towel

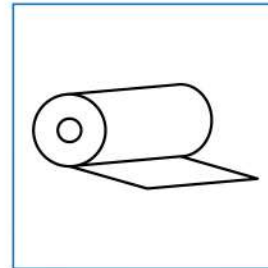

No	Code	Specification	Packing
1	Kitchen Towel Recycle	70 sheets x 228mm x 2ply	2 rolls x 10 packs x 1ctn

6 Wet Tissue

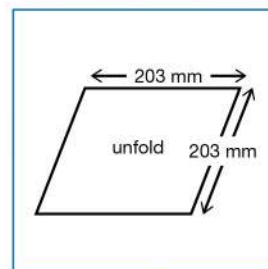

No	Code	Specification	Packing
1	Wet Tissue Plastic Packaging Packaging Colour Available: Pink, Red, Yellow, Maroon, Purple, Blue, White	Tissue Size: 203mm x 203mm x 1ply Packing Size: 13cm x 6cm	100 pcs x 10 packs x 1 ctn
2	Wet Tissue Aluminium Foil Packaging Packaging Colour Available: Silver, Light Green, Golden, Black, Red, Yellow, Maroon, Purple	Tissue Size: 203mm x 203mm x 1ply Packing Size: 13cm x 6cm	100 pcs x 10 packs x 1 ctn

Note: Logo Printing Available

7 Laminated Tissue Coaster

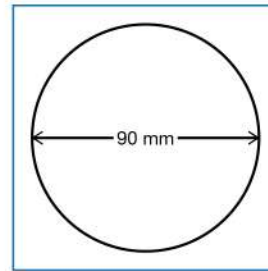

No	Code	Specification	Packing
1	Laminated Paper Coaster	90mm Diameter	500 pcs x 20 packs x 1ctn

Note: Logo Printing Available

Industrial Tissue

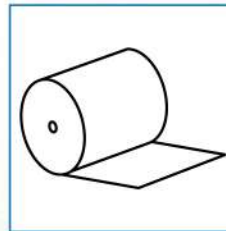

No	Code	Specification	Packing
1	Industrial Roll Tissue (IRT) Pulp	26cm x 1000 meter x 1ply	2 rolls x 1ctn